

STERIL AIR PRO

TECNO-GAZ



INTRODUCTION



Steril Air is a unique product, manufactured by Tecno-Gaz in Italy since 1995.

Steril Air is a device to sterilize ambient air, thanks to the action of UV-C tubes, with proven action against virus, bacteria, and yeast, with demonstrated efficiency by numerous studies.

A fan creates a depression and ambient air is absorbed and treated with the action of 4 UV-C tubes of 25 W each, and the radiation is enhanced with the light reflector for the internal parts of Steril Air.

Steril Air can treat 120 m³ hour, and bacterial reduction of 90% can be evidenced after 3 hours of continuous action.

Steril Air can be fixed on the wall or used with a mobile stand to move it from 1 room to another.

Steril Air is valid product not only for Dental Clinics, but also for Medical clinics, and other ambiances.

STERIL AIR

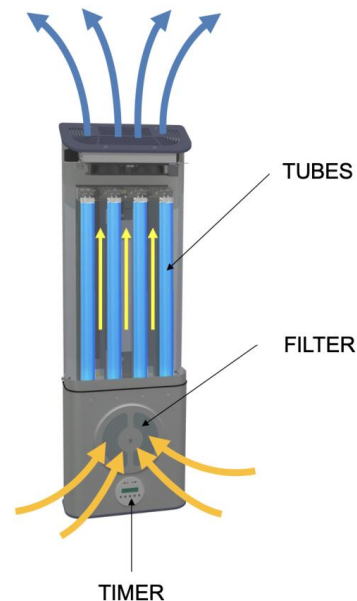

Steril Air contains 4 UV-C lamps of 25 W each , and 100 W overall.

The internal case reflects and maximizes the UV-C lamps action.

Many scientific articles are available about the UV-C lamps action.

STERIL AIR

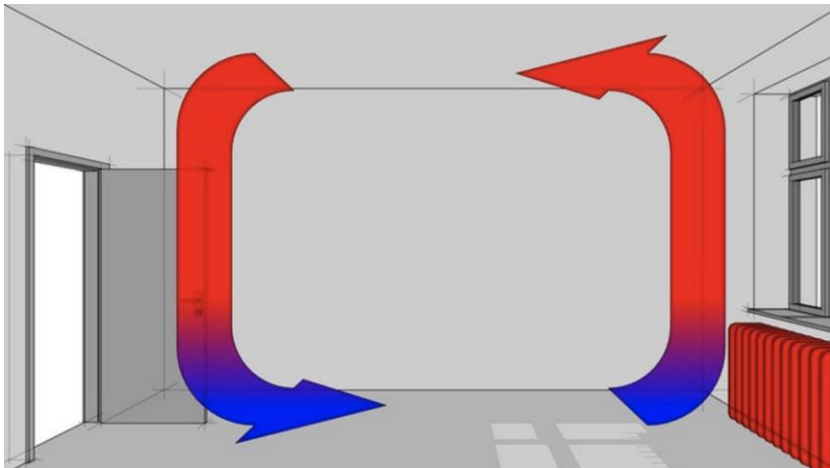

An interchange flow is established between hot air going up and cold air going down.

It is called convection effect.

Cold air is absorbed by **STERIL AIR** passing through the ventilator and filter that create an aspiration effect.

STERIL AIR / TUBES UV-C & VIRUS



Coronaviruses are extremely sensitive to UV-C tubes action.

One single passage through the Steril Air chimney is enough to destroy 90% of the virus content.

We also refer to virus that are directly exposed to the UV-C tubes action, meaning that go through the Steril Air.

TECHNICAL INFO

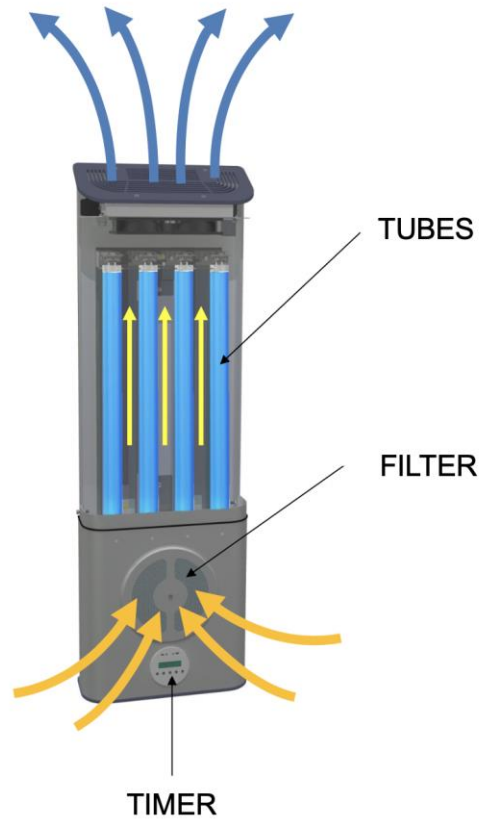

Flow	120 m3 / Hour
Noise rate	32 db
Tubes	4 Tubes UV-C 25W G13T8 (7 W UGI)
External UVC radiation	None
Structure	Aluminum
Lifetime - Tubes	9.000 hours
Wavelength	253,7 nm
Consumable	Filter antidust and UV-C tubes
Dimensions	A: 82 CM L: 27 CM A: 11 CM
Weight	15 KG

STERIL AIR - MEASURES

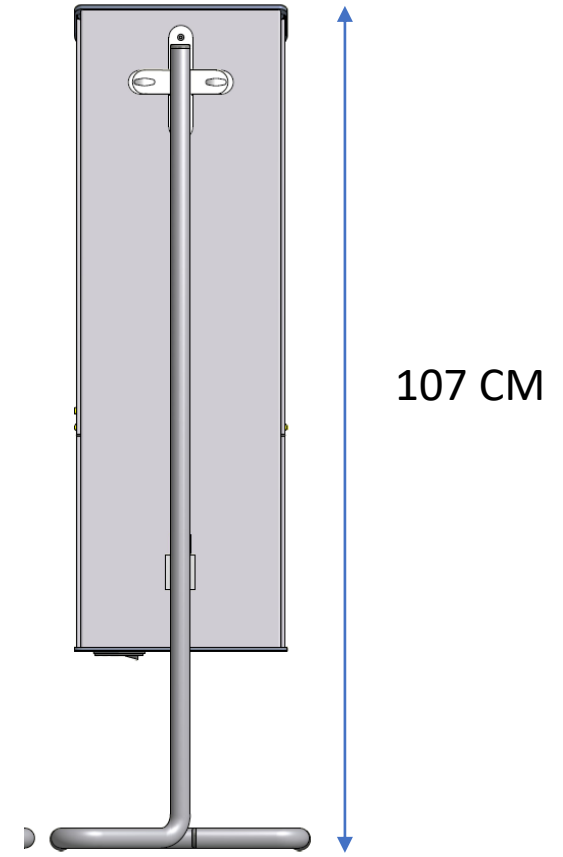

MAINTENANCE

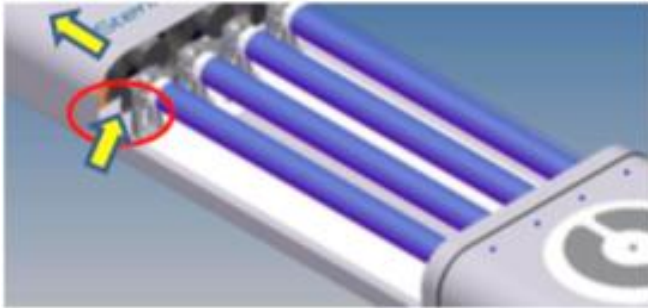

- Replacement of 4 lamps and 1 filter

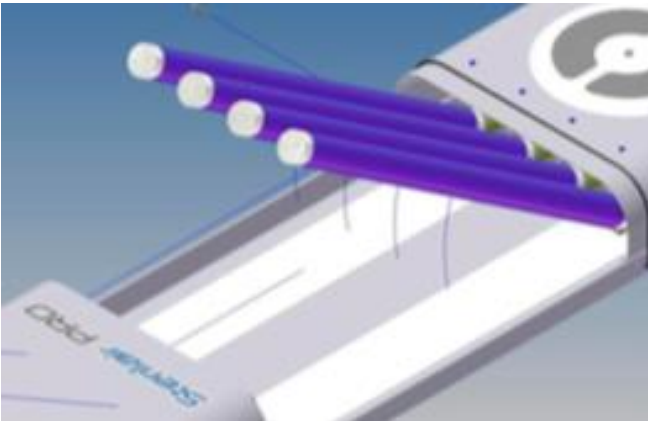

INSTALLATION

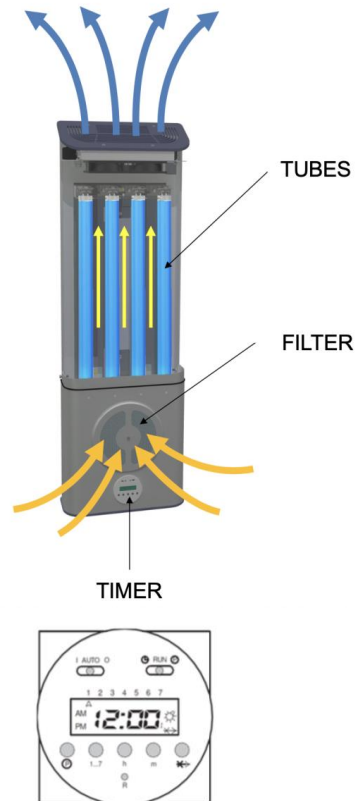

- Plug & Play.
- Wall Mounted
- Optional Floor-Stand Support
- On / Off
- Or programmer – temporizer
 - Week (5 d, 6 d, o 7 d)
 - Time

TECNO-GAZ

